

hl 4/14/13

Scanhugger HL 4/14/13 is an all-round shredder, capable of shredding all types of woodwaste (solid wood, particleboard, MDF, pallets, cardboard, paper, demolition waste wood) depending on the material to be processed and the desired chip quality, the machine can be mounted with 2 different rotor types and various screen sizes.

Scanhugger HL 4/14/13 er en all-round træknuser, der er velegnet til knusning af alle typer træaffald (massivt træ, spånplade, MDF, paller, pap, papir, kartonageaffald). Afhængig af materialetype og ønsket flisstørrelse kan maskinen monteres med 2 rotortyper til henholdsvis fine/grove flistyper.

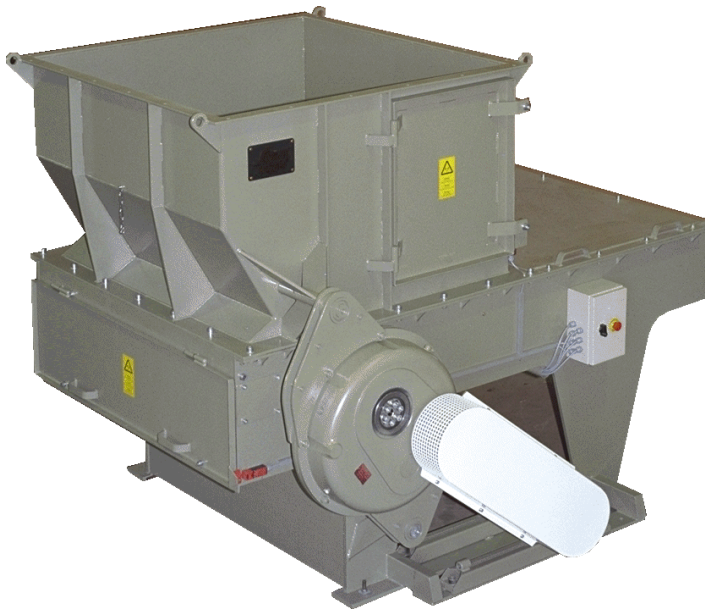

Rotor/knife
Rotor/kniv



screen
sold

Technical data / Tekniske data.

Hopper dimension / Magasinmål		1358 x 1370 mm
Hopper volume / Magasinindhold		1,6 cbm
Rotor diameter / Rotor diameter		Ø 370 mm
No.of knives / Knivantal	*	40 / 27
No.of counterknives / Antal modstål		3
Rotor speed/ Rotoromdrejninger	**	80 - 100 ⁻¹
Main motor / Hovedmotor	**	22 - 75 kW
Screen perforation / Soldperforering	**	15 - 70 mm
Chip length / Flislængde	**	20 - 200 mm
Capacity / Kapacitet	**	400-2000kg/60min
Weight / Vægt		4555 kg
Sound level / Lydtrykniveau L _{pa}	***	86,5 dB

* Depending on rotor and type of knife

** Depending on motor size, material and screen perforation

*** In accordance with ISO/DIS 11204, prEN 691

Technical alterations reserved / Ret til tekniske ændringer forbeholdes

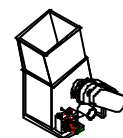

HL 2 SERIE

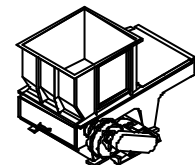

HL 3 SERIE

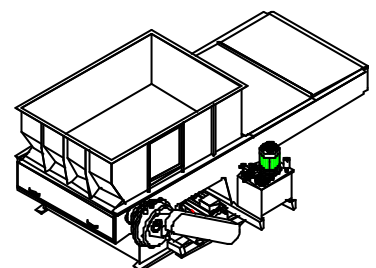

HL 4 SERIE

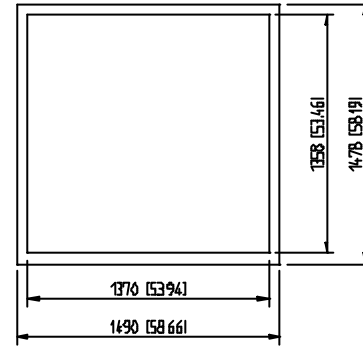
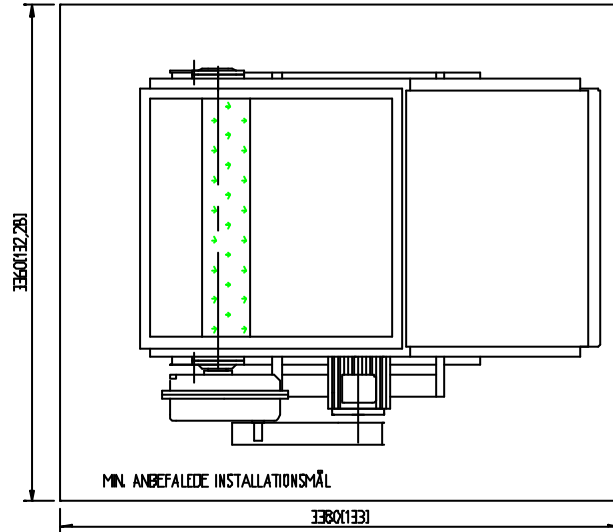
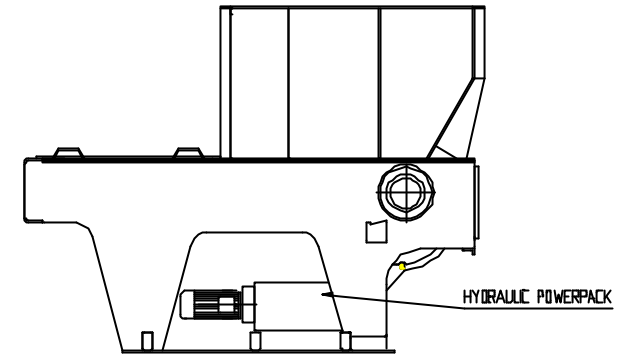
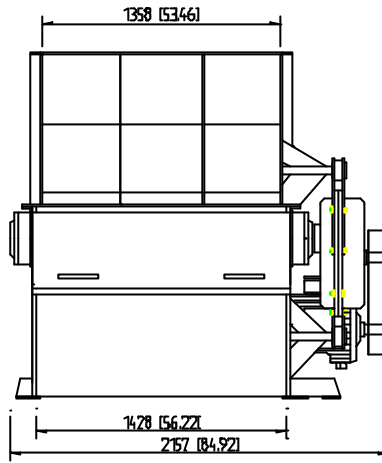
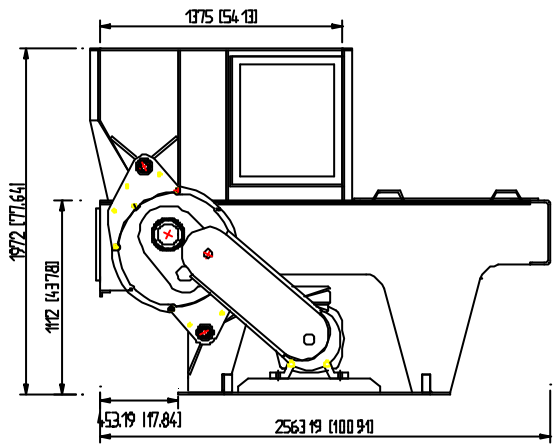

FLANGE MAGASINTOP

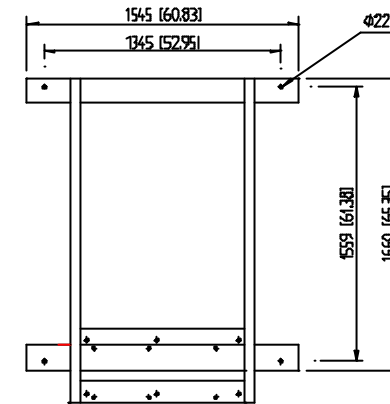

MASKINFOD

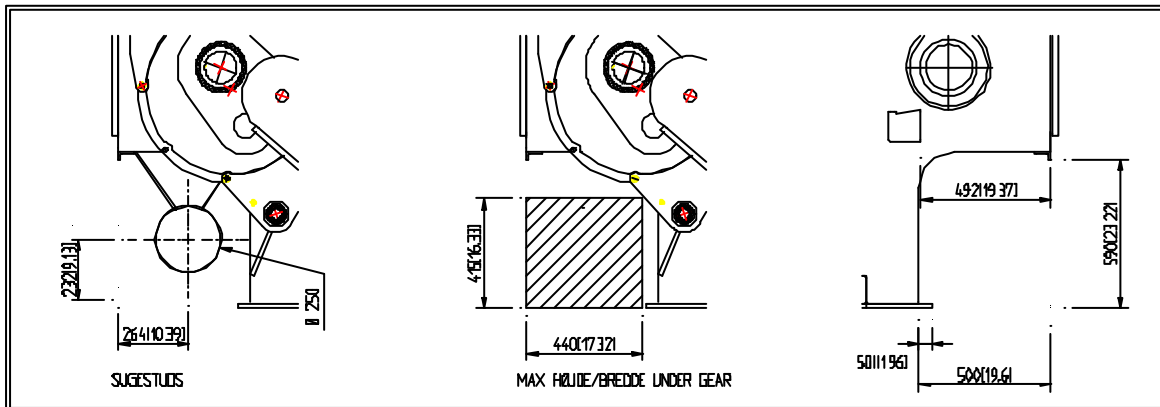

SUGESTUDS

MAX HØJDE/BREDDI UNDER GEAR

HL 4/14/13 MOUNTED WITH REDUCTION GEARBOX TA 100/100/D
ON LEFT MACHINE SIDE
ALL MEASURES IN MM(INCH)

MAIN MOTOR FRAME SIZE
VOLTAGE/ FREQUENCY
HYDRAULIC MOTOR
SCREEN PERFORATION
CHIP CONVEYING SYSTEM

ALL TECHNICAL ALTERNATIVES RESERVED

Pos nr	Mål	Betegnelse	Formål	Skala	Bemærkning
Kont	Sign				Erstatning
					Erstatning af
					Tagtallet
		<p>HEDTRAK A/S 286 0000 7242 7234 2176</p>			
<p>Skulle tegning og alle kopiering eller på nogen anden måde genbruges for fremgår! Alle rettigheder er forbeholdt og må ikke overføres til andre personer uden vores skriftlige tilladelse.</p>					